

YCQ9 series(PC class)

Automatic transfer switch

OPERATION INSTRUCTION

Standard: IEC 60947-6

CNC

Deliver
Power For Better Life

 Before installing and using this product, please read this manual carefully and pay more attention to safety.

YCQ9 series

Automatic transfer switch

Dear use

Thank you for using the YCQ9 series automatic transfer switch produced by our company. We sincerely hope that this product can bring convenience and benefits to your work and life. We welcome your valuable opinions and suggestions during use. We will continue to provide you with warm and thoughtful service. In order to ensure your personal and property safety and use this series of products correctly and rationally to avoid unnecessary losses, please read this manual carefully before installation, circuit connection, operation, maintenance and inspection. This instruction manual introduces the structure, working principle, service conditions, installation and commissioning of the automatic transfer switch, which is helpful for you to use the product correctly and reasonably. If you have any questions, please consult our company. The user shall be responsible for any adverse consequences caused by failure to operate in accordance with the instruction manual.

Precautions

1. Please read this manual carefully before use, and operate in strict accordance with the operating specifications of the manual to avoid unnecessary losses.

2. The YCQ9 series is a professional intelligent electrical product. Non-professionals are prohibited from operating and maintaining it, otherwise it may cause electric shock or product damage.
3. The dielectric performance test of this series of products has been carried out according to the standard before leaving the factory. If the test is repeated, the controller must be removed to prevent damage to the electronic components in the controller.
4. The neutral wires of the four-pole automatic transfer switch should be connected to the corresponding incoming wires of the N poles of the "normal power supply" and "standby power supply". , otherwise the automatic transfer switch cannot work normally.
5. For three-pole automatic transfer switch appliances, the neutral wire of the system must be connected to the neutral wire auxiliary terminal of the automatic transfer switch. Do not connect wrongly and the wiring must be reliable, otherwise the automatic transfer switch will not work.
6. The casing of the automatic transfer switch must be reliably grounded to ensure the safety of the operator.
7. Do not install the automatic transfer switch in

outdoor, humid, direct sunlight, high temperature, large vibration shock, conductive dust, etc., otherwise it will shorten the service life of the product or cause adverse reactions.

8. When both the normal power supply and the standby power supply fail, manual closing is prohibited.

9. In order to ensure the reliability of the automatic transfer switch, a switching test should be carried out regularly to confirm the normal operation of the switch and ensure the continuity of power supply for important loads.

10. When carrying out normal maintenance and troubleshooting of the load circuit, the automatic control function of the automatic transfer switch must be turned off, so that the automatic transfer switch is in a double-point state, and the power supply of the load is cut off to avoid unnecessary property loss and personal injury.

11. Please use the "manual" mode for debugging when the automatic transfer switch is overhauled or regularly checked.

12. Products that are not used for a long time should be protected from moisture and dust. Before use, they must be debugged according to the specified content, and they can be put into operation after normal operation.

1. Applications

YCQ9 series automatic transfer switch is suitable for AC 50Hz, rated working voltage AC230V (2P)/AC400V, and rated working current up to 630A in two-phase/three-phase four wire dual circuit power grids. They automatically connect one or several load circuits from one power source to another power source to ensure the normal power supply of the load circuit. This product is suitable for important places such as industrial, commercial, high-rise, and residential buildings.

2. Type designation

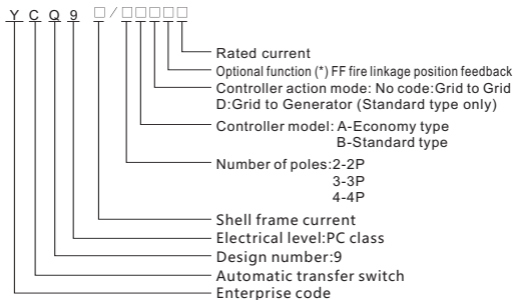

Note: The standard type has an optional fire linkage position feedback, the code is FF, and there are no other options. If this function is not selected, there

is no code by default; the economy type has no optional function, and the default display is no code. There is no B type for the 63 frame.

3. Standard

IEC 60947-6

4. Normal operating conditions

4.1 Ambient air temperature: the upper limit of the ambient air temperature is +40°C, the lower limit is -5°C, and the average temperature within 24 hours does not exceed +35°C;

4.2 Altitude: the altitude of the installation site does not exceed 2000m;

4.3 Atmospheric conditions: The relative humidity of the atmosphere does not exceed 50% when the ambient maximum temperature is +40°C. It can have a higher relative humidity at a lower temperature, for example, it can reach 90% at +20°C. Special measures should be taken for occasional condensation caused by temperature changes;

4.4 Pollution degree: Degree 3.

5. Technical data

Model	YCQ9-63	YCQ9-125T	YCQ9-250T	YCQ9-630
Standard	GB/T 14048.11			
Rated working voltage(V)	AC-230/50Hz (2P)		AC-400/50Hz	AC-415V/50Hz
Rated insulation voltage	800		1000	
Rated current(A)	16,20,25,32 40,50,63	16,20,25,32 40,50,63,80, 100,125	125,140,160 180,225,250	250,315,350 400,500,630

Impulse withstand voltage(KV)	8		12	
Rated impulse withstand current Icw(KA)	5/30ms	10/30ms		25/1s
Rated short-time making capacity Icm(KA)	8	17		52.5
Number of poles	2P/3P/4P			3P/4P
Use category	AC-33B			
Contact transfer time(S)	0.6±20%			
Transfer action time (S)	1.3±10%			
Return time (S)	1.3±10%			
Power off time (S)	0.6±20%			
Electrical level	PCclass			
Installation and connection	Vertical fixed installation			
Wiring method	Screw wiring			
Connection method	Front panel			
Operating method	Auto/Manual			
EMC environment	Environment B			
The maximum number of conductors allowed to be clamped	1		2	
Protection degree	IP20 (Except for the main circuit wiring terminal)			
Screw tightening torque	2.5	6	10	22
Screw breaking torque	3	10	15	26
Power supply voltage deviation range	160 ± 10% (Economy, Standard) also with edge dyeing			
Normal working range	85%Ue~110%Ue			
Special requirements	None (Normal installation conditions)			
Whether the product is suitable for isolation	Yes			
Switch position	Normal (I), Power Off (O), Standby (II)			
Mechanical life	8000(*)			4000(*)
Electrical life	2000(*)			1000(*)

Note: *Maintainable

6. Features and functions

YCQ9 series automatic transfer switch is a new generation of PC-class products combined with advanced digital electronic control technology. The product has the characteristics of small size, energy saving, convenient installation, reliable double interlocking, etc., and has advanced and complete functions.

6.1 Small size, novel appearance, sliding cover design, flexible operation, safe and reliable.

6.2 Instantaneous structure design, using double springs to drive the design ingeniously with simple and stable structure.

6.3 Rotary contact structure, annular arc extinguishing device design, good arc extinguishing performance, and long working life of contacts.

7. Controller Display and Operating Instructions

7.1 Explanation of display interface of economy type and standard type controller (63 frame)

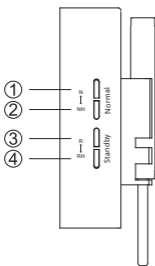

1. Normal power supply indication.

2. Normal closing instructions.

3. Standby power indication.

4. Standby closing indication.

7.2 Explanation of display interface of economy type and standard type controller (125-630 frame)

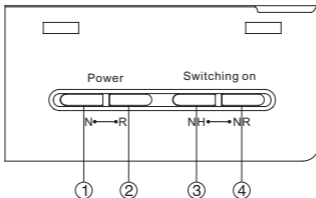

1. Normal power supply indication.
2. Normal closing instructions.
3. Standby power indication.
4. Standby closing indication.

8. Product structure

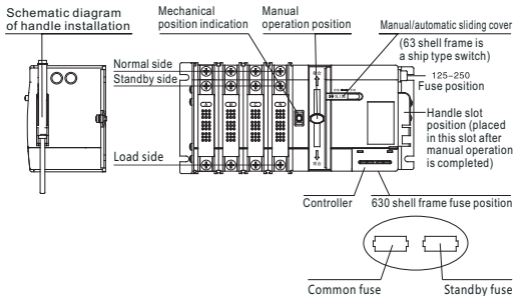

a. Manual/automatic sliding cover: the internal control circuit power supply of the control switch, the manual/automatic sliding cover is in the "automatic position", and the manual/automatic sliding cover is in the "automatic position", achieving automatic operation of the switch; The manual/automatic sliding cover is in the "manual position", and the switch can only be manually operated;

b. The operating handle is usually removed and inserted into the slot of the handle. It is installed and used only for emergency operations.

9. Technical data

Controller		A (Economy type)	B (Standard type)
Installation mode: Integrated		Integrated	Integrated
Rated working voltage		230V	230V
Rated working frequency		50Hz	50Hz
Working position	Normal power supply closing	■	■
	Standby power supply closing	■	■
	Two power sources disconnected	■	■
Auto operation	Auto operation	■	■
	Handle operation	■	■
	Controller button operation	-	-
	Remote control	-	-
Key operation	Key to normal	-	-
	Key to standby	-	-
	Key to fully open	-	-
Monitor	Phase monitoring	Normal three phase, Standby single phase	
	Monitoring common undervoltage	■	■
	Monitoring common overvoltage	-	-
	Monitoring common voltage loss	■	■
	Monitoring common phase failure	■	■

Controller		A (Economy type)	B (Standard type)
Monitor	Monitoring standby undervoltage	-	-
	Monitoring standby overvoltage	-	-
	Monitoring standby voltage loss	■	■
	Monitoring standby phase failure	-	-
	False fire alarm	-	■
Conversion method	Automatic switching and recovery	■	■
	Mutual backup	-	-
	Automatic switching without automatic recovery	-	-
Grid connection	Grid to grid	■	■
	Grid to generator	-	□★
Display	Screen	Indicator	Indicator
	Whether the common power supply is normal	■	■
	Whether the standby power supply is normal	■	■
	Normal power supply opening and closing	■	■
	Standby power supply opening and closing	■	■
	Common power supply voltage value	-	-
	Standby power supply voltage value	-	-
	Manual/auto	■	■
	Delay time display	-	-
	Fault alarm display	-	-
	Conversion times display	-	-
	Generator start status	■	■
Parameter settings	Adjustable conversion delay(S)	Fixed value	Fixed value
	Adjustable return delay(S)	Fixed value	Fixed value
	Manual/automatic switchable	■	■
	Adjustable undervoltage	Fixed value	Fixed value
	Adjustable overvoltage	-	-
Other functions	Fire feedback	□	□
	Fault alarm output	-	-
	Position feedback output	■	■
	Fault memory	-	-
	Communication	-	-

Controller		A (Economy type)	B (Standard type)
Other functions	Three-phase unbalance setting	-	-
	Conversion rejection alarm	-	-
	Wrong wiring alarm	-	-

Note: "-" has no such function; "□" is an optional function; "■" is a standard function; with * means that the 63 frame does not have this function.

10. Installation and Use

10.1 Product main circuit wiring diagram

(Power phase sequence must be consistent)

3-pole main circuit wiring

4-pole main circuit wiring

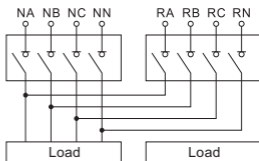
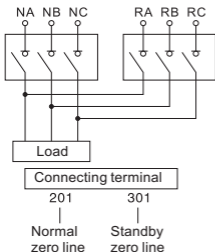

Note: When connecting the main circuit of the product, the ports on the normal power supply and standby power supply need to be connected by the user themselves (SCPD) to protect the electrical appliances to prevent load short circuits and burning of the product and circuit.

Note: The 3-pole product can only operate normally when the neutral wire is connected to the controller terminals 201 and 301.

10.2 Controller secondary wiring diagram

10.2.1 Economy type controller secondary wiring diagram

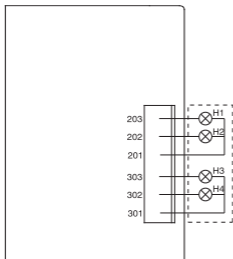

1. Common signal AC220V output (201, 202, 203): 201 is the common terminal (3-pole, neutral wire input), 202 is the power indicator, and 203 is the closing indicator.
2. Standby signal AC220V output (301, 302, 303); 301 is the common terminal (for 3-pole, neutral wire input), 302 is the power indicator, and 303 is the closing indicator.
3. The dashed part is connected by the user, and H1~H4 are AC signal indicator lights.

10.2.2 Standard type controller secondary wiring diagram

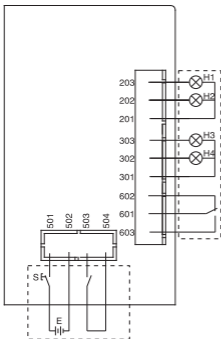

1. Common signal AC220V output (201, 202, 203): 201 is the common terminal (3-pole, neutral wire input), 202 is the power indicator, and 203 is the closing indicator.
2. Standby signal AC220V output (301, 302, 303) 301 is the common terminal (for 3-pole, neutral wire input), 302 is the power indicator, and 303 is the closing indicator.
3. Fire linkage control (501, 502, 503, 504): 501 and 502 are DC24V fire signal power inputs, and 503 and 504 are passive feedback contact outputs after executing fire protection. (63 shell rack only has 501 and 502 ports, without 503 and 504 ports)
4. Power generation start stop control(601, 602, 603): 601 is the common terminal, 602 is the start passive contact output, and 603 is the stop passive contact output. (63 shell rack without ports 601, 602, 603)
5. The dashed part is connected by the user, and H1~H4 are AC signal indicator lights; S is the self-locking button, and E is the DC24V signal provided by the fire center.

11. Installation and Use

11.1 Overview and mounting dimensions

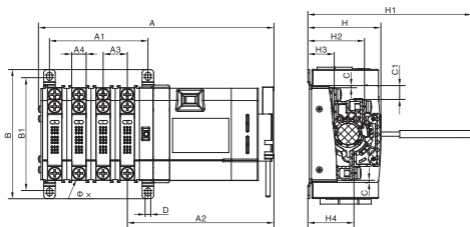

YCQ9-63 Specifications

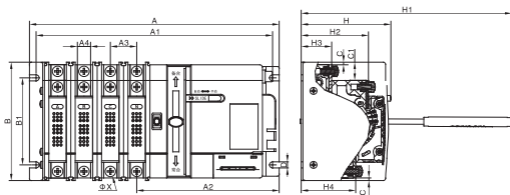

YCQ9-63 -125-630 Specifications

Specifications	A			B	H	A1			B1	A2	A3	A4	H1	H2	H3	H4	C	C1	D	Φx
	2P	3P	4P			2P	3P	4P												
YCQ9 -63	171	193	215	138	68	44	66	88	106	136	22	13	152	52	24	43	2	13	5.2	6
YCQ9 -125	229	259	289	136	102	214	244	274	100	162	30	15	240	77	35	62	4	21	7	6
YCQ9 -250	302	347	393	170	128	283	328	374	125	207	45.5	25	257	96	44	79	4	22	9	8
YCQ9 -630	/	528	596	255	192	/	501	569	188	325	68	49	367	144	65	118	6	40	13	120

Note: The operating handle is usually removed and used for emergency or manual operation.

11.2 Troubleshooting

Common fault phenomena	Fault cause	Exclusion method
The indicator light does not display after power on	Poor contact of the main circuit wire	Check and connect the corresponding wires properly
	The product is not connected to the neutral wire, especially for 3-pole products	
	Power supply phase loss or phase failure	Check whether the voltage of each phase of the main circuit is normal
	Fuse blown	Replace the fuse
Controller light flashes frequently (economy, standard)	One power supply of the product is not connected to the neutral wire, or the N-pole of the product is wrongly connected to the live wire	Correctly connect the wires (main circuit) according to the instructions, and wrong connection will burn the controller

12. Packaging list

Name	Unit	Quantity	Note
Automatic Transfer Switch	Set	1	Including controller and operating handle
User manual	Piece	1	
External signal wiring terminal	Set	1	

13. Ordering Instructions

Users should provide the following detailed information when ordering:

1. Users should indicate the product model, current specifications, number of poles, and other information when ordering.

2. If there are special installation conditions or special site usage requirements, the user shall provide corresponding technical information or negotiate with our company. For example, ordering automatic transfer switch appliances with a frame current of 125A, 4-pole integrated type, standard controller, grid power generation, rated current of 100A, 50 units. Namely written as: YCQ9-125/4B 100A 50 units. Kind reminder: When the lifespan of this product ends, in order to protect our environment, please do a good job in recycling the product or component materials. For materials that cannot be recycled, please handle them properly and do not discard them randomly. Thank you very much for your support!



CERTIFICATE

Product Model: YCQ9 series (PC class)

Standard: IEC 60947-6

Inspector: **CNC001**

Production date: Printed on the product
or package.

This product is qualified according
to the delivery inspection

A vertical red bar containing the white text 'CNC' in a bold, sans-serif font.

YCQ9 series (PC class)

CNC ELECTRIC

Tel: 0086-577-61989999 Fax: 0086-577-61891122

www.cncele.com E-mail: cncele@cncele.com